



Downlighting & Accent Lighting Innovations

MikroLite™ • Beam 6 Adjustable Downlight • Adjustable Accents • Fixed Downlights



02 MikroLite™ 1.5

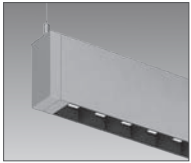

Sculpt
New

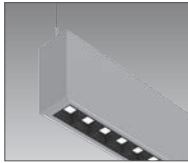

Beam 2
New

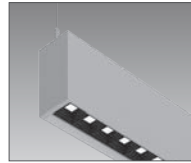

Beam 2
Deep-Cell
New

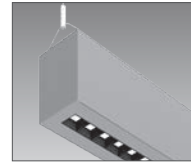

Beam 4
New

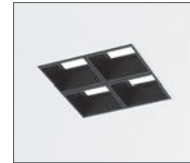

Recessed
Downlights
New

12 MikroLite™ 1.0

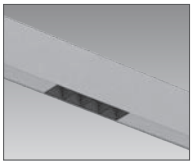

Stencil Pendant
New

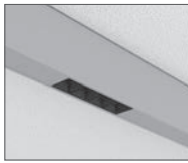

Stencil Surface
New

Adjustable Downlight 14

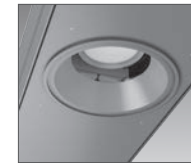

Beam 6
New

20 Adjustable Accents

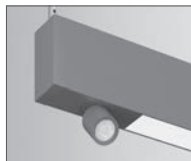

Sculpt

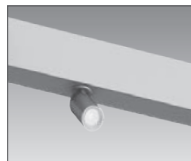

Stencil Pendant

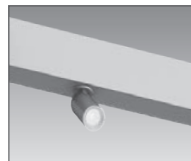

Stencil
Pendant D/I
New

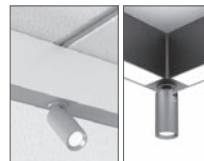

Stencil Surface

Fixed Downlights 28

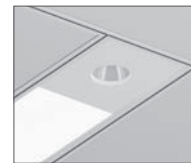

Beam 4

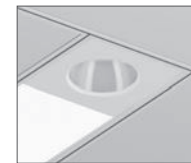

Beam 6

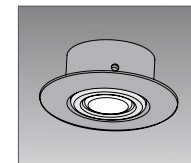

Twin Beam 2, 3, 4

Downlighting & Accent Lighting Innovations

A wide range of options to layer lighting and create interest

Welcome to the extended family of integrated downlights and accent lighting products designed for our linear portfolio.

Axis Lighting understands the importance of layering light to increase visual interest in a space. This explains our efforts in recent years to develop a broader selection of innovative tools for the lighting community. Our offering features several new designs, including our latest endeavor: MikroLite.

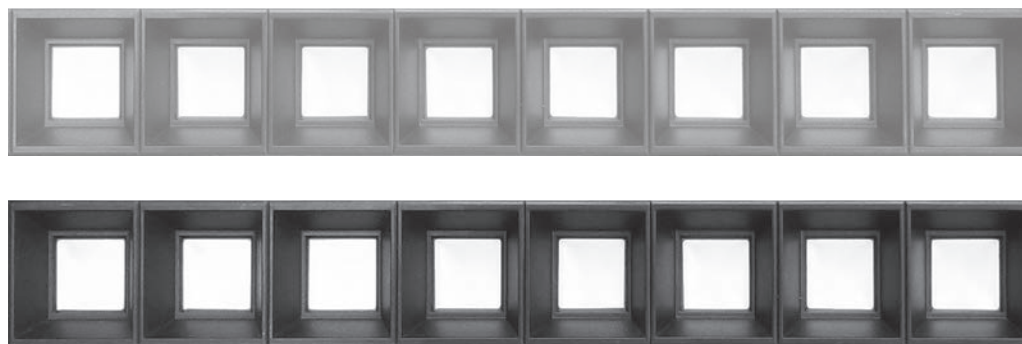

MikroLite 1.5 Recessed Downlight.
(8-cell linear module)

MikroLite™



4' Sculpt Pendant Direct/Indirect segments with black MikroLite 1.5 optics

MikroLite™

Visually discreet and yet so powerful

Introducing MikroLite, the smallest linear downlight with the highest efficacy... Another leading-edge innovation from Axis Lighting.

MikroLite is unlike any other miniature downlight in its category. The 1.5" module delivers exceptional output levels suited to general lighting and high-ceiling applications, while the 1" module provides stunning accent lighting.

But MikroLite's design flexibility and advanced technology offer so much more. Discover all you can do with MikroLite.

Designing with MikroLite™

A modular approach for maximum flexibility

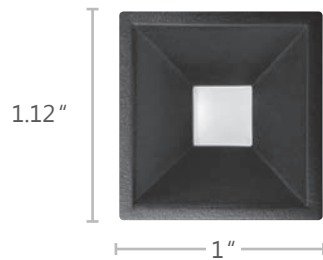

MikroLite 1.0

MikroLite 1.0 is a high-CRI, glare-free linear downlight ideal for accent lighting applications.

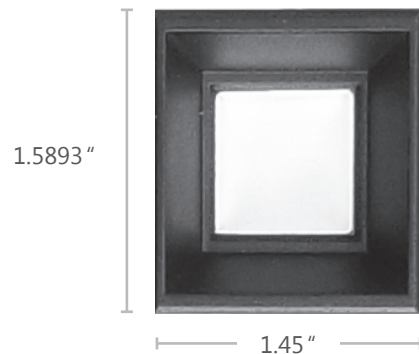

MikroLite 1.5

MikroLite 1.5 is the first high-performance, high-CRI, glare-free, color tunable linear micro downlight. In fact, it is so powerful, it can be used for general lighting and high-ceiling applications.

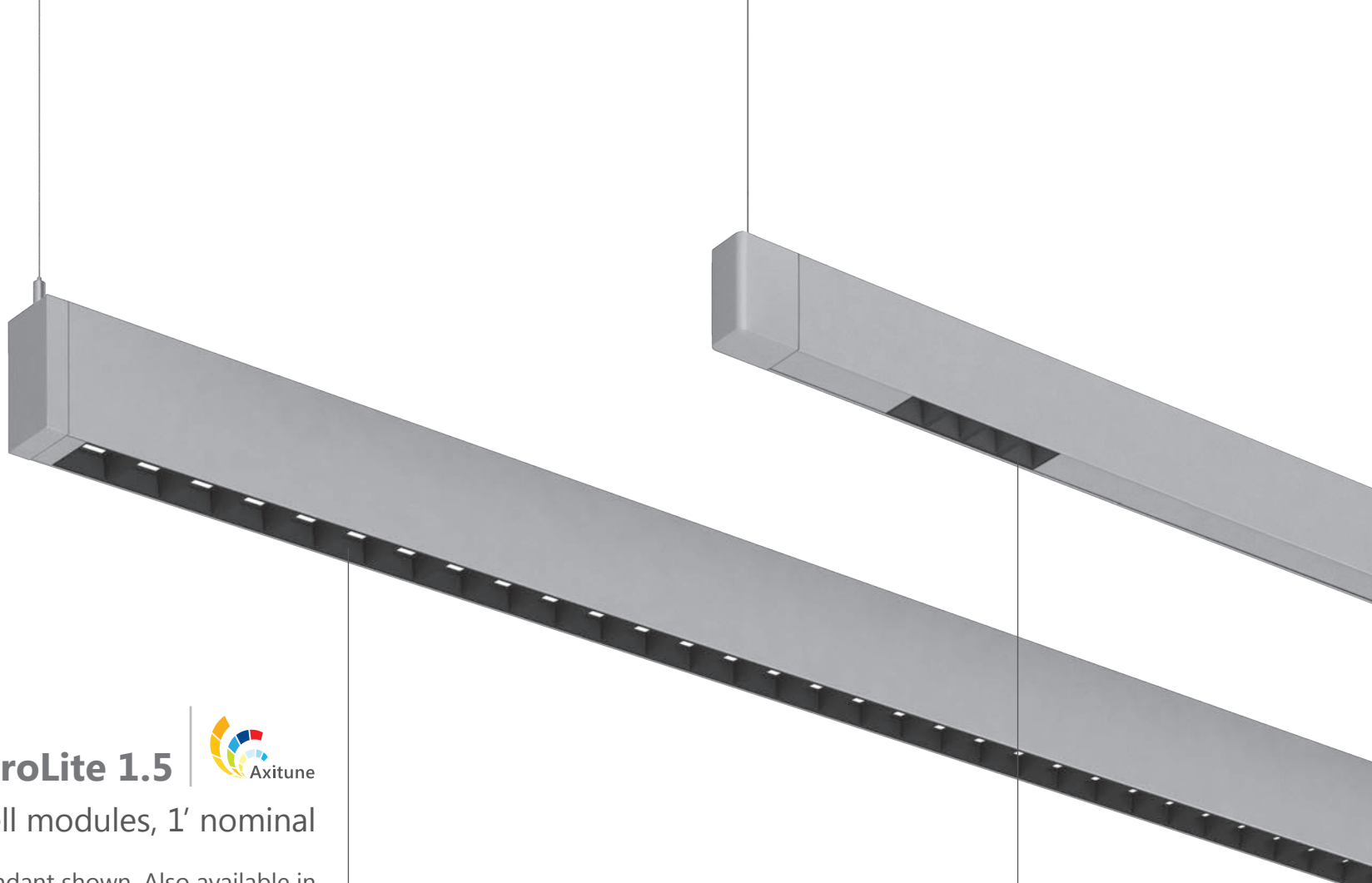

MikroLite 1.5



8-cell modules, 1' nominal

Sculpt Pendant shown. Also available in Sculpt Recessed, Sculpt Surface, Beam 2, Beam 4 and Recessed Downlights.

MikroLite 1.5 features significant advances recognized by the 2018 IES Progress Report.



MikroLite 1.0

4-cell modules, 4" nominal

Stencil Pendant shown. Also available in Stencil Surface.

MikroLite™ 1.5

Crisp beams and a quiet ceiling line

MikroLite 1.5 incorporates a highly esthetic 1.5" square-in-square optical system that delivers superior visual comfort and flawless color mixing, even at high light output levels. Its tunable precision optics produce streak-free vertical surfaces.

- ✓ 90+ CRI
- ✓ Efficacy: Up to 111lm/W with black finish (90 CRI Tunable White)
- ✓ Output: Up to 1100 lm/ft
- ✓ Axitune tunable white: 2700K-5000K (lowest Duv), 2700K-6500K
- ✓ Fixed CCT: 2700, 3000, 3500, 4000K
- ✓ Choice of standard or deep-cell optics with Beam 2
- ✓ Available in black and grey finish



MikroLite 1.5 can combine with multiple optics and blank segments in Sculpt (Pendant, Recessed, Surface), Beam 2 and Beam 4 housings.

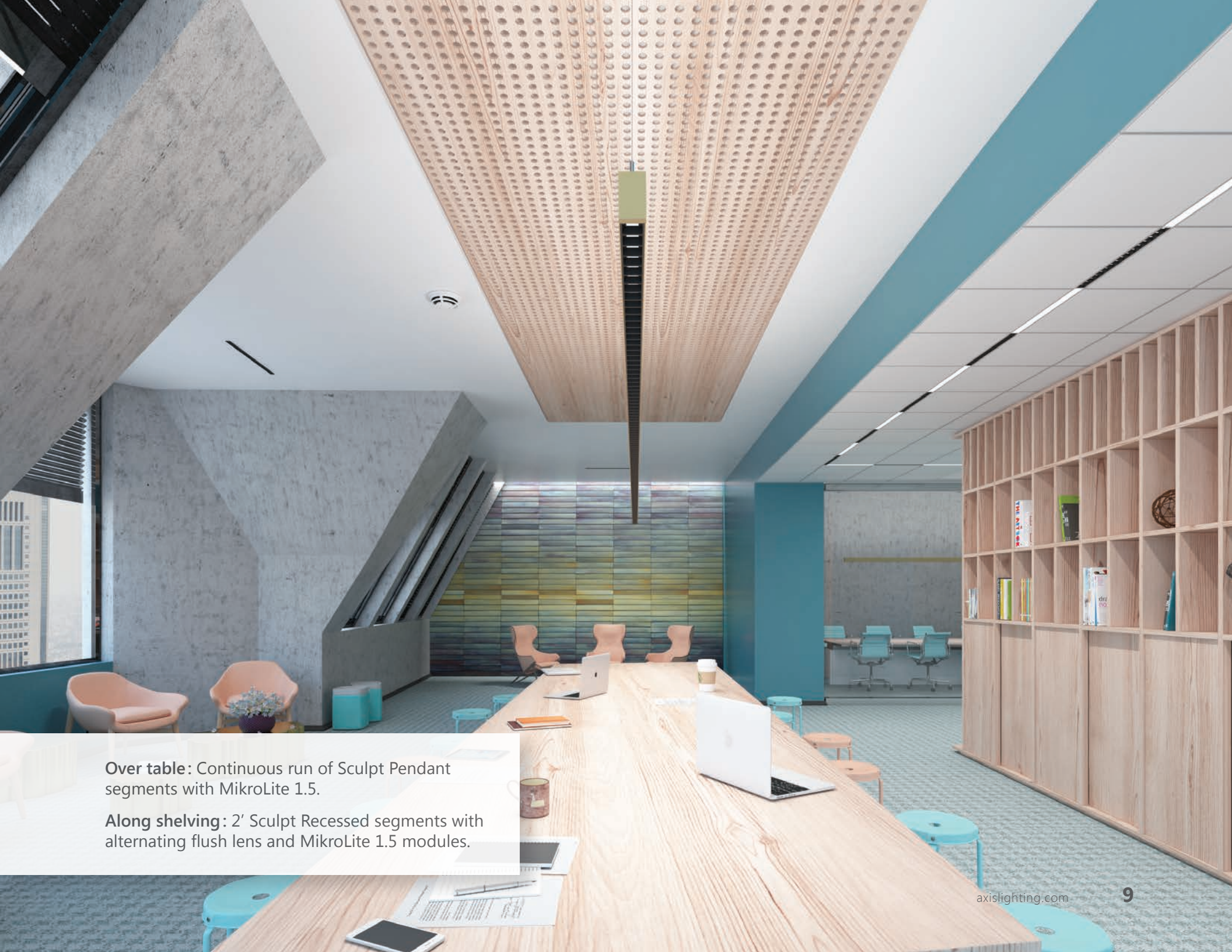

Over table: Continuous run of Sculpt Pendant segments with MikroLite 1.5.

Along shelving: 2' Sculpt Recessed segments with alternating flush lens and MikroLite 1.5 modules.

MikroLite™ 1.5 Recessed Downlights

Complement the ceiling with small-scale downlights

Expand your lighting design toolbox with the minimalist look of MikroLite 1.5 Recessed Downlights, available in 4- and 8-cell linear forms, as well as 4-cell square forms.



These modules feature the same clean ceiling lines and high-lumen, energy-efficient performance found in other MikroLite 1.5" cells. As a result, they are equally suited for general lighting and high-ceiling applications.



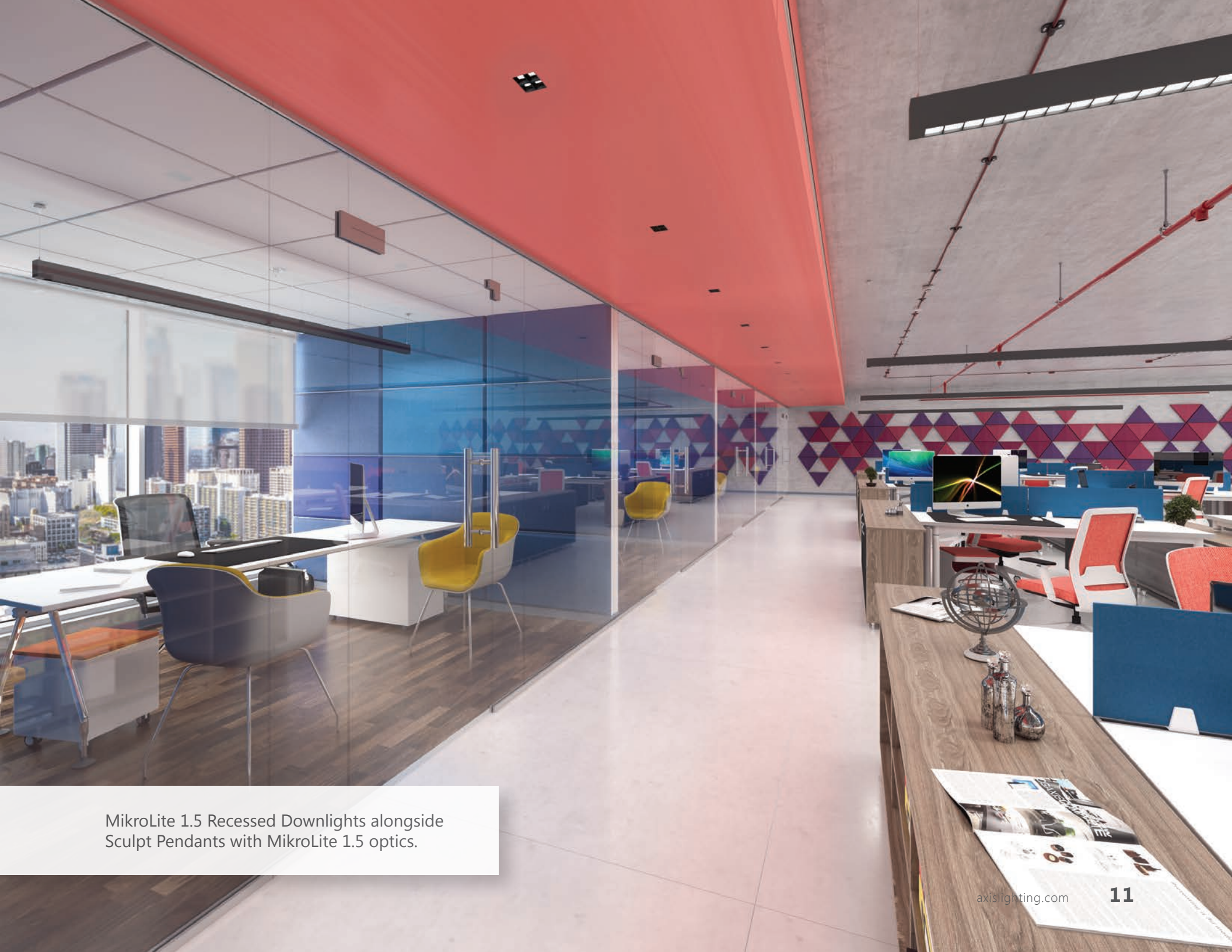

MikroLite 1.5 Recessed Downlights alongside
Sculpt Pendants with MikroLite 1.5 optics.

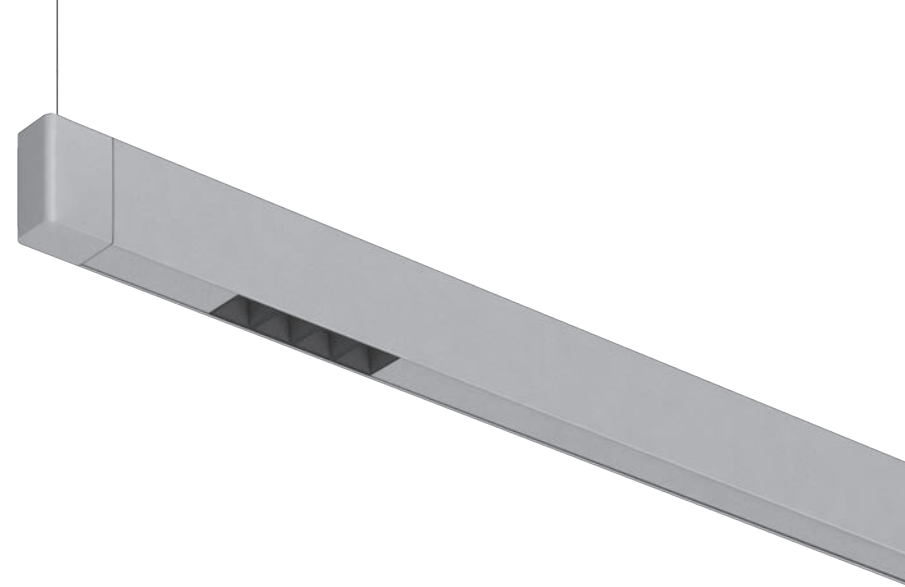

MikroLite™ 1.0

Well-defined beams. Clutter-free ceiling.

MikroLite 1.0 features a highly esthetic 1" square-in-square beveled TIR optical system that provides superior visual comfort. Its precision optics produce flawless color mixing and streak-free vertical surfaces.

- ✓ Choice of narrow or wide beam
- ✓ CRI: 80 or 90 CRI
- ✓ Output: 500 lm per 4-cell module
- ✓ Fixed CCT: 2700, 3000, 3500, 4000K
- ✓ Available in Stencil Pendant and Stencil Surface
- ✓ 6' minimum segments for Stencil Pendant Indirect with MikroLite optics
- ✓ Available in black and grey finish



Stencil Pendant Indirect
with Mikrolite 1.0 optics

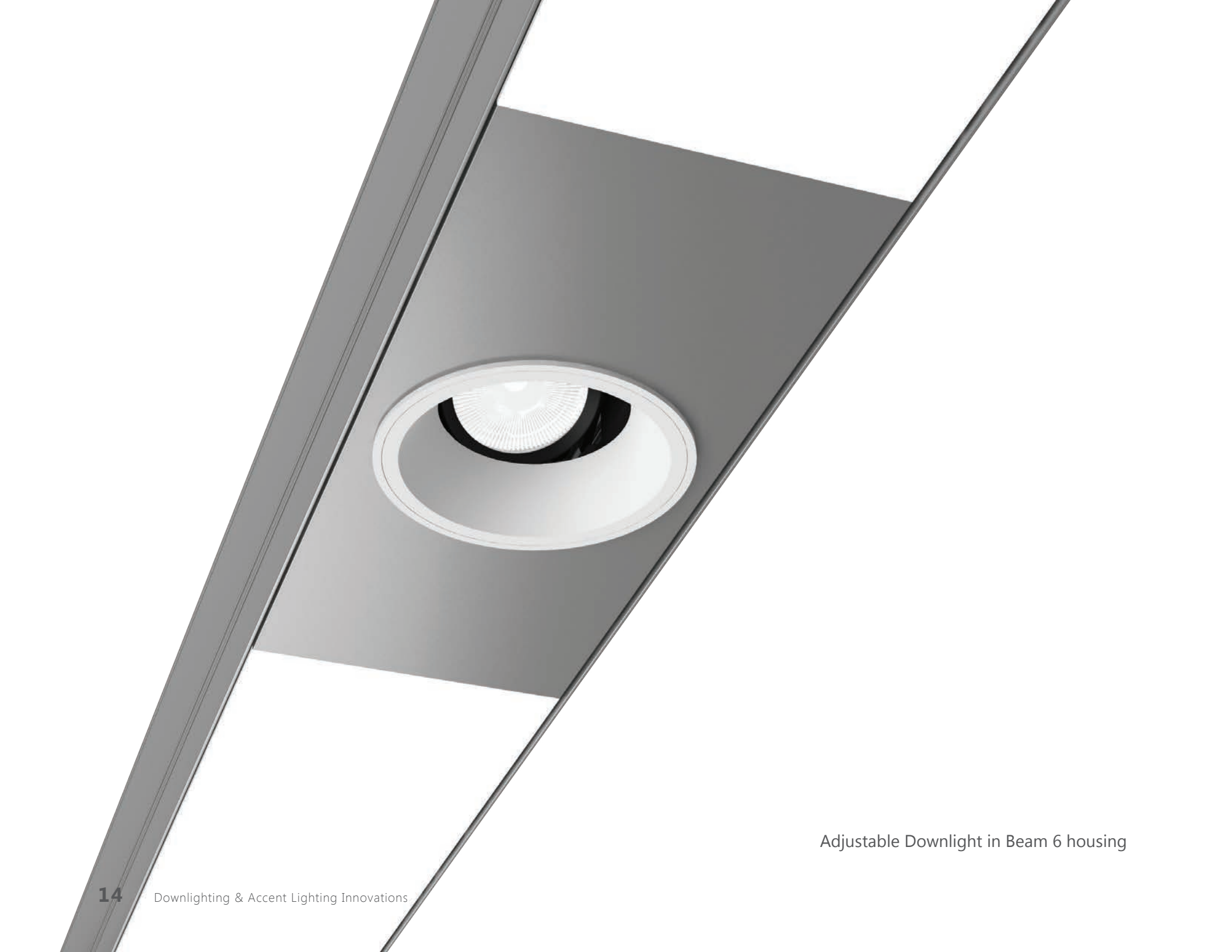

Adjustable Downlight in Beam 6 housing

Adjustable Downlight

Beam 6 Adjustable Downlight

Highlight the space with elegant accents

Create ambience without clutter using Beam 6 Adjustable Downlights, a highly appealing, visually comfortable solution for linear products.

Combine Beam 6 general lighting with these powerful accent lights featuring a clean ceiling appearance. Or use Adjustable Downlights as stand-alone modules in a Beam 6 housing.

The regressed cone and cam-action locking device deliver precise aiming that eliminates flashing on the trim.

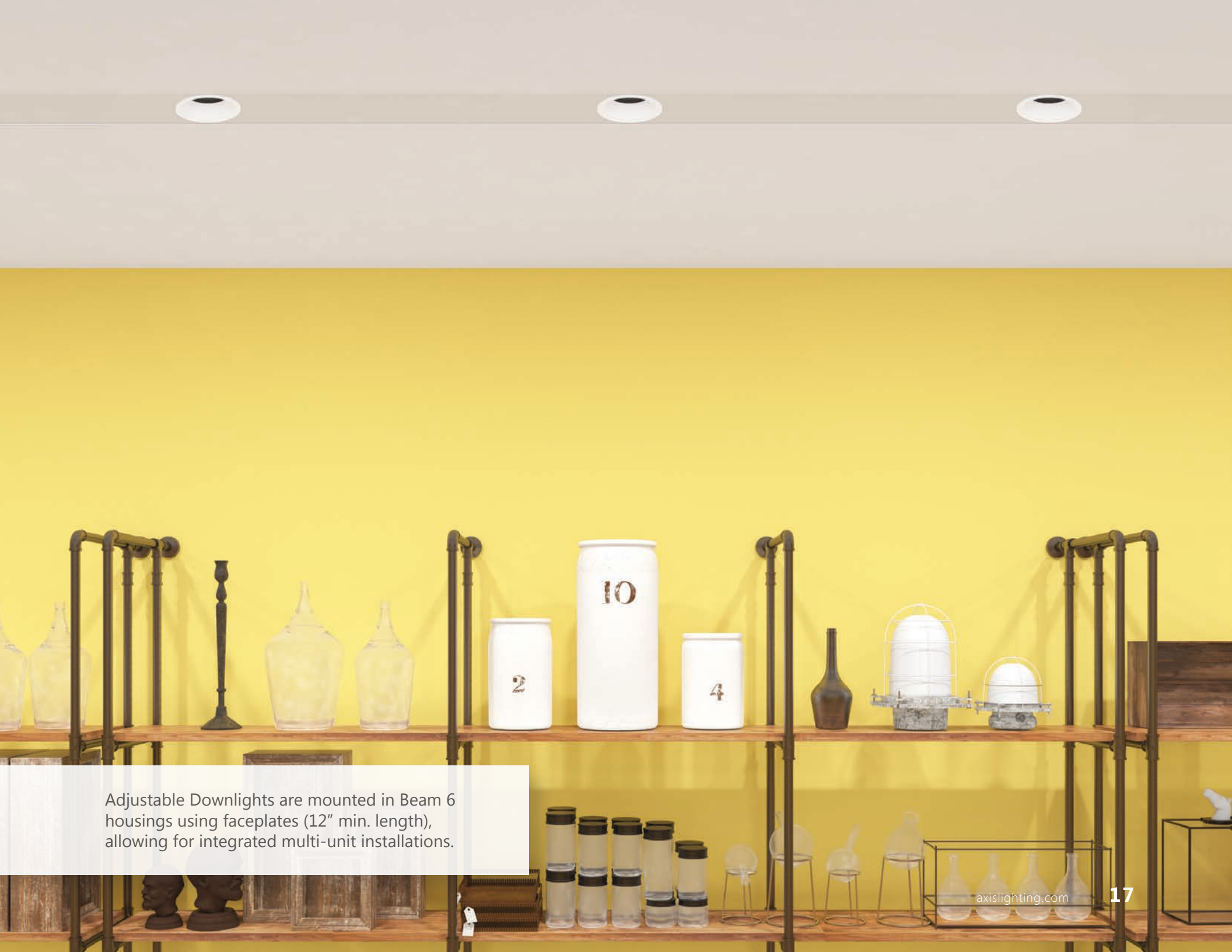

Adjustable Downlights are mounted in Beam 6 housings using faceplates (12" min. length), allowing for integrated multi-unit installations.

Beam 6 Adjustable Downlight

Powerful features for architectural spaces

Easy-to-aim accents feature cam-action locking mechanism and crisp light beams without any artefacts. Choice of white or black finish.

- ✓ Up to 2000 lm
- ✓ 3.5" aperture
- ✓ Lockable 360° rotation, with up to 35° tilt
- ✓ Interchangeable TIR optics
- ✓ Up to 95 lm/W
- ✓ Choice of beam spreads (wide, medium, narrow)
- ✓ 80 or 90 CRI
- ✓ 2700K – 4000K
- ✓ Integral driver

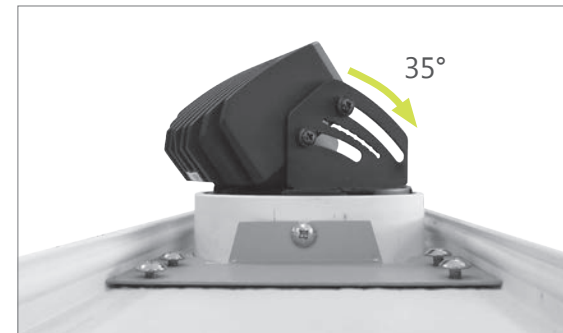

35 degree adjustability

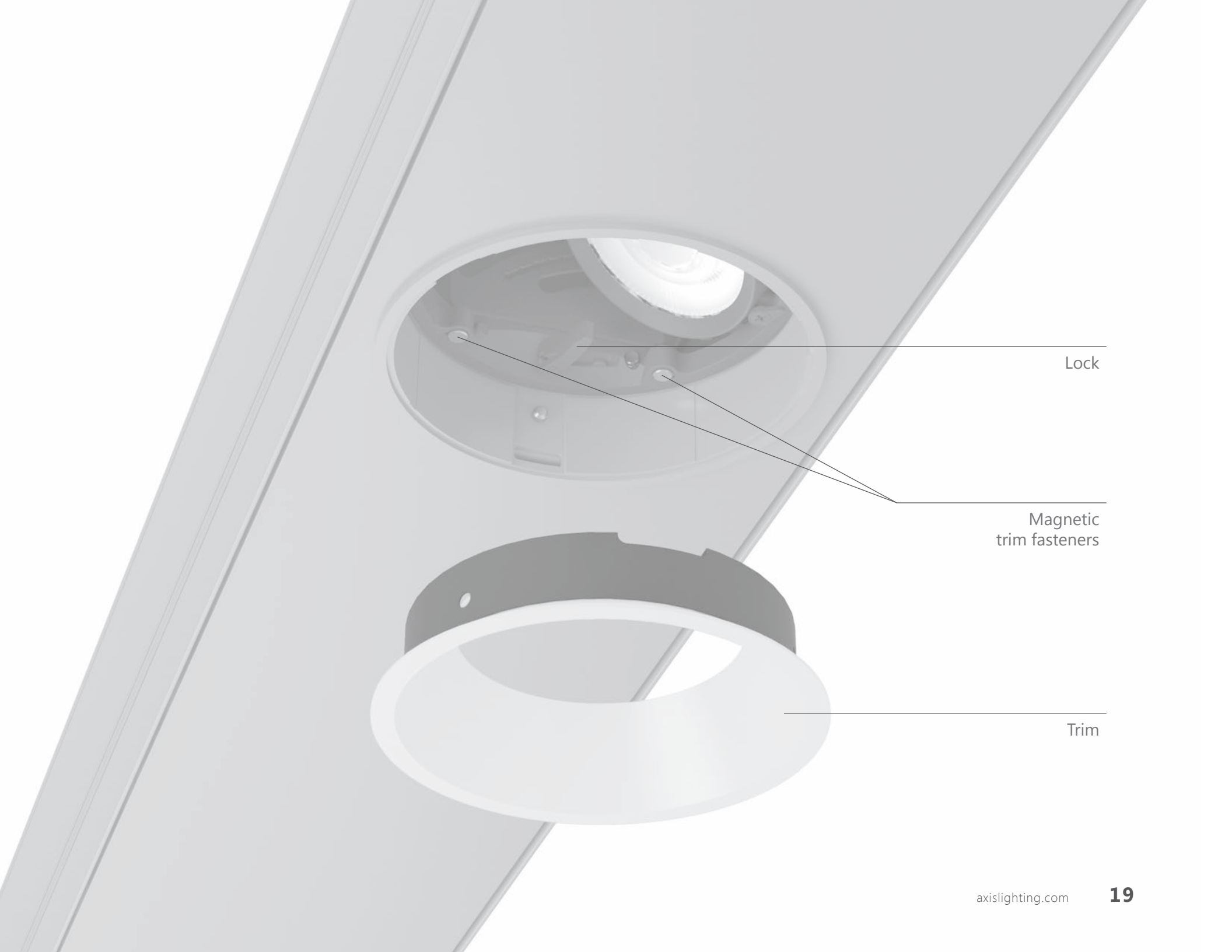

Lock

Magnetic
trim fasteners

Trim



Adjustable Accents



Stencil Pendant



Adjustable Accents

Integrated task lighting for Sculpt and Stencil

Create appealing layers of light with Adjustable Accents. Bring the excitement of theatre and stage lighting to your project.

Expand the lighting toolbox with flexible accent modules that can meet the most demanding lighting specification requirements. Available in white, black, aluminum and custom finishes (e.g. wood).

Sculpt Accents

Create the right mood

Position Sculpt Accents along runs in combination with lensed segments. Thanks to exclusive patent-pending end-mount technology, you can also position modules at the end of runs or in the corner of geometric forms.

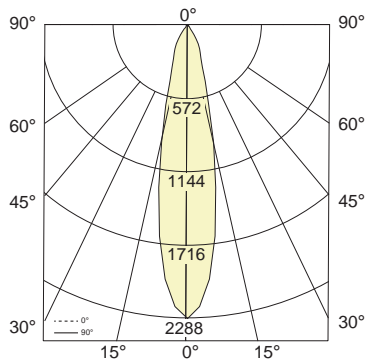

Output: 500 lm nominal

Wattage: 7.5W

Efficacy: Up to 75 lm/W

CPCP: 2287 cd @24°, 796 cd @36°, 446 cd @ 60°

CCT: 3000K

CRI: 80

Dimming: 0-10V (Integral) to 10%



Options

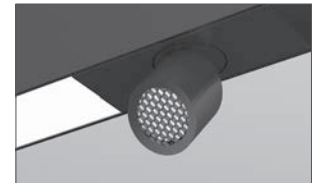

Hex Cell louver



Corner mount

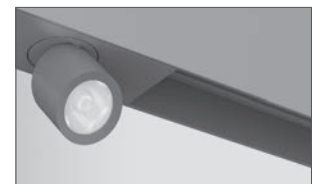

With or without
channel cover

Superior adjustability



Semi-Recessed

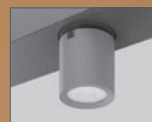

Extended



Pivoted

Sculpt Accents feature a 1.25" aperture.
Minimum spacing: 4".



Stencil Accents

Add visual interest with style

You have the freedom to position Stencil Accents anywhere along the channel, individually or in clusters. Compatible with Stencil Pendant, Pendant D/I and Surface.

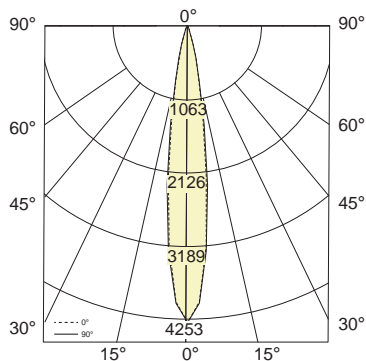

Output: 450 lm nominal

Wattage: 5.5W

Efficacy: Up to 81 lm/W

CPCP: 4253 cd @20°

CCT: 3000K

CRI: 80

Dimming: 0-10V (Integral) to 5%



Stencil Accents feature an 11/16" aperture.
Minimum spacing: 4".

Options

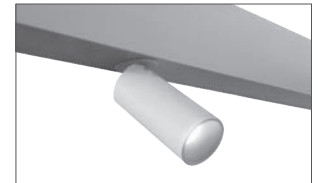

Snoot
(Extended Shielding)



Hub mount
(Stencil Surface Only)

Fixed Downlights

Fixed Downlights

Enhance the space with integrated downlights

Position almost anywhere along the channel, between segments and at luminaire ends. Blank segments accept multiple units.

1 3/4" Downlight insert



Nom. Lumen Output	Beam Spread Options		
900 lm	25°	34°	46°
1250 lm	25°	34°	46°

3" Downlight insert



Nom. Lumen Output	Beam Spread Options		
900 lm	25°	38°	55°
1500 lm	25°	38°	55°

Luminaires	2" MR16 LED Gimbals	2" LED Gimbals	LED Inserts
Twin Beam 2		✓	
Twin Beam 3		✓	
Twin Beam 4		✓	
Beam 2		✓	
Beam 3	✓		
Beam 4	✓		1 3/4"
Beam 6	✓		3"

Featuring Solite lens for crisp beams, excellent light quality. CRI: 90 (R9 > 50).



LINEAR
STUDIOS



Beam 6 with LED inserts

About Axis Lighting

Founded in 1991 and still family owned and managed, Axis is an important source for architectural lighting across North America and around the globe.

Over the last decade, the company has exhibited remarkable growth thanks to its commitment to Design Flexibility, Optimal Energy Efficiency and Responsive Customer Care. That leadership effort now extends to developing Innovative Lighting Technologies, such as SurroundLite™, on an ongoing basis.

On the strength of a broad and expanding product line, Axis has successfully completed lighting projects for high-profile clients including Apple, Chrysler, The Empire State Building, Google, Hyundai, Time Warner and McGill University, among many others.

Axis has the drive and the expertise to meet your needs and provide architectural lighting... your way.



We reserve the right to change specifications without notice.
Please consult our website for the most current technical information
and to locate your nearest Axis representative.

1.800.263.AXIS **T** 514.948.6272 **F** 514.948.6271

axislighting.com

© 2018 Axis Lighting Inc.