



Zen



Architectural Compact Downlighting

Featuring SurroundLite™

axis

Zen Square

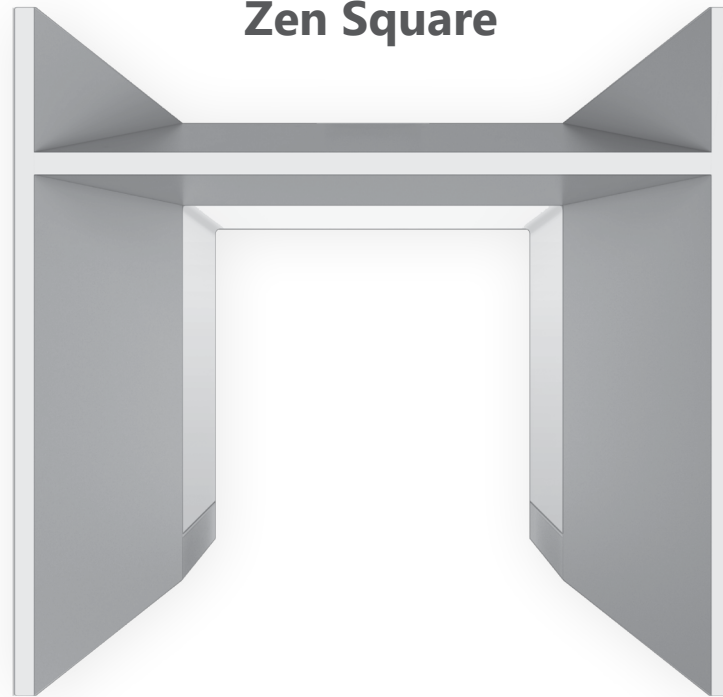

Actual Size

with **Spotless Acrylic Shielding** (SO) shielding



Zen

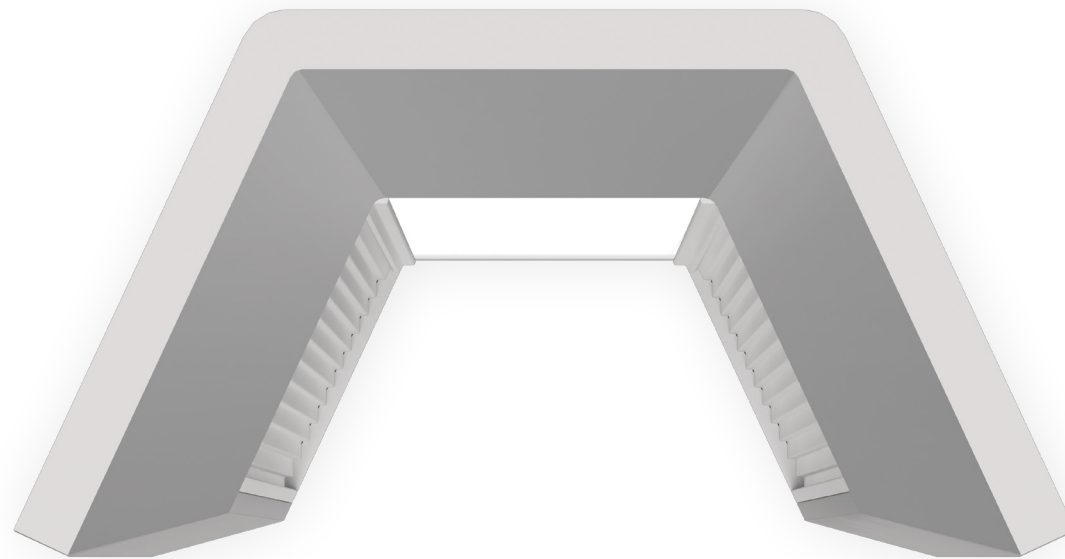

Actual Size

with **Microgroove Extruded Aluminum** (MAL) shielding



→ Verhalmatafel

6

Penthouses
Johannes Wimmer

THE ARMENIAN
Johannes Wimmer

Zen

A sleek family of luminaires with superior lighting power

These patent-pending inverted-U forms provide soft, comfortable lighting. They emit more downward luminance from the top than from the sides. Pendant versions use SurroundLite™ optics to open up the space by delivering ample, glare-free downlighting and reflected light throughout.

Zen

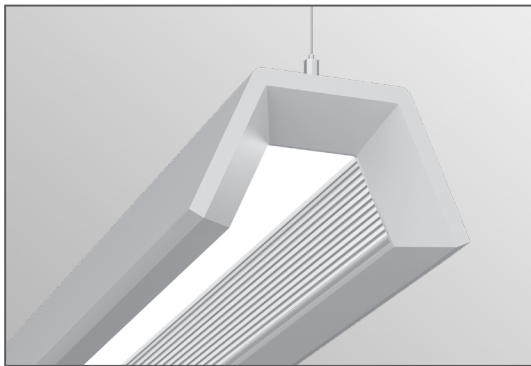

Pendant
Surface
Recessed (Beam)

Zen Square

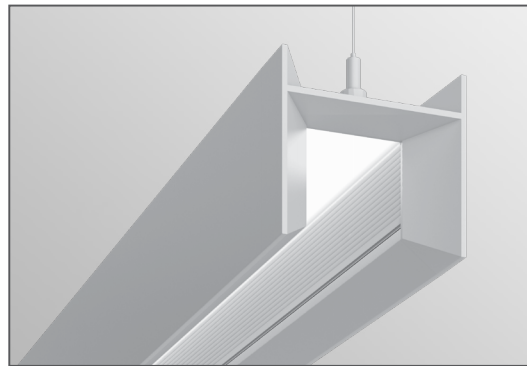

Pendant
Wall



Versatile and compact forms

Choose between two profiles to match various architectural interiors.

Zen

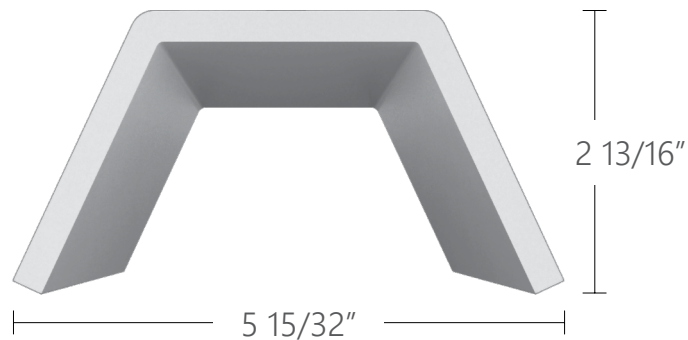

Zen Square

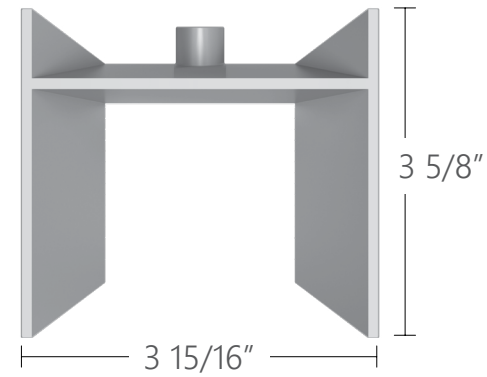

Integral LED Mini-Driver



This dimmable integral LED mini-driver is one of the smallest of its kind in the world. Reduce installation time and costs by eliminating the need for remote drivers.





The SurroundLite™ story

Zen and Zen Square pendants incorporate patented SurroundLite technology developed by Axis. The result is a richer visual experience with additional light distribution that opens up a space and pleases the eye.

High-Performance Optics

SurroundLite produces a visually appealing non-Lambertian 3D spherical batwing light distribution.

- Uniformly diffuse lighting similar to daylight.
- Wide planes of light in all directions: ceiling, corners, walls.
- Reduced contrast on the ceiling, improving visual comfort.
- Wide spacing results in fewer luminaires needed to light a space.

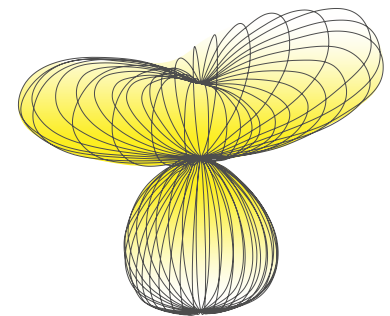



Innovative optics

Pendant versions feature unique SurroundLite™ direct-indirect optical systems to deliver superior visual comfort and maximum lighting effectiveness while reducing installation time and costs.

Zen

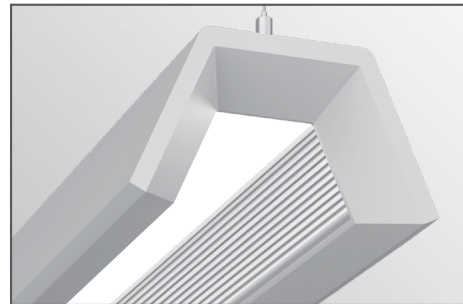
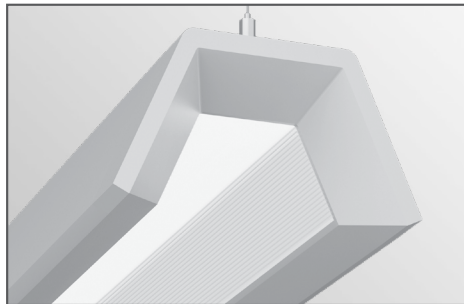

Zen Square

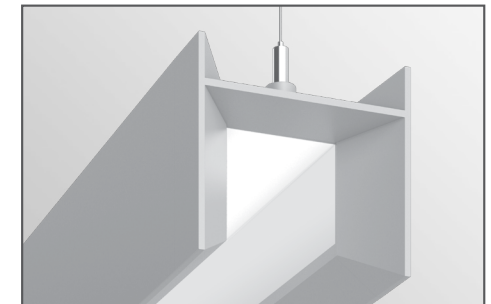
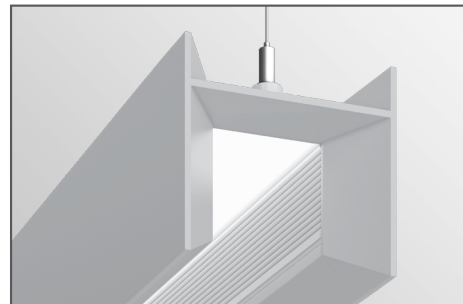
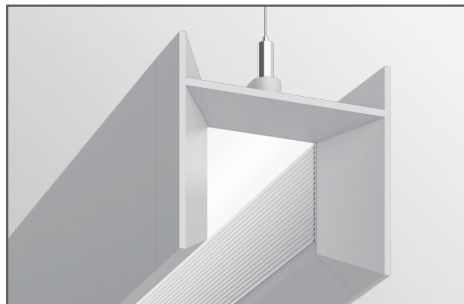

One-piece acrylic lens with **Microgroove Side Spotless (MSO)** side shielding.

Microgroove Extruded Aluminum (MAL) side shielding with upper acrylic lens for a soft low brightness appearance.

Spotless Acrylic Shielding (SO) side shielding option provides a comfortable uniform glow of light. Only available with Zen Square.



New levels of architectural integration

Zen Beam offers style-matched recessed lighting opportunities. High-efficacy downlighting elements disappear into the ceiling while providing excellent lighting design flexibility.

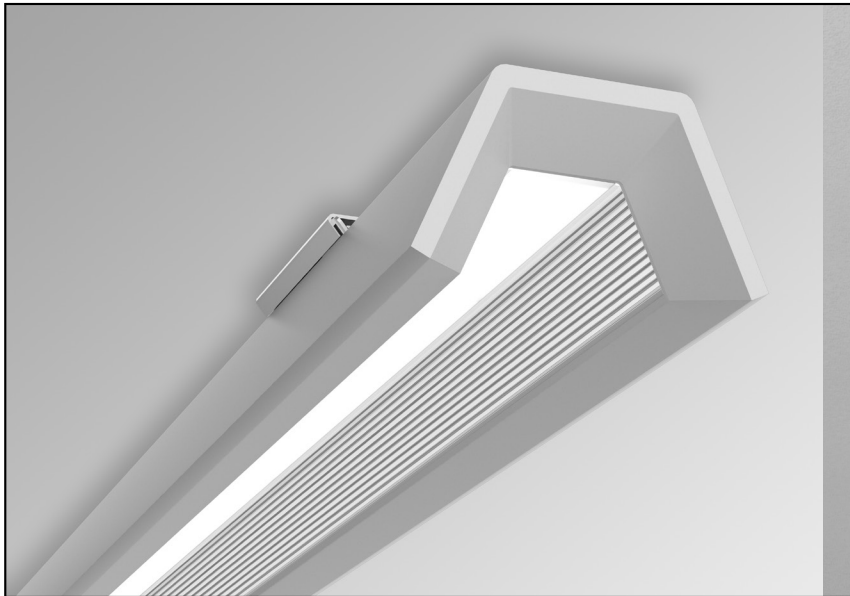

Zen surface luminaires are ideally suited for delivering high-quality visually comfortable light in areas with restricted plenums or no plenum access.

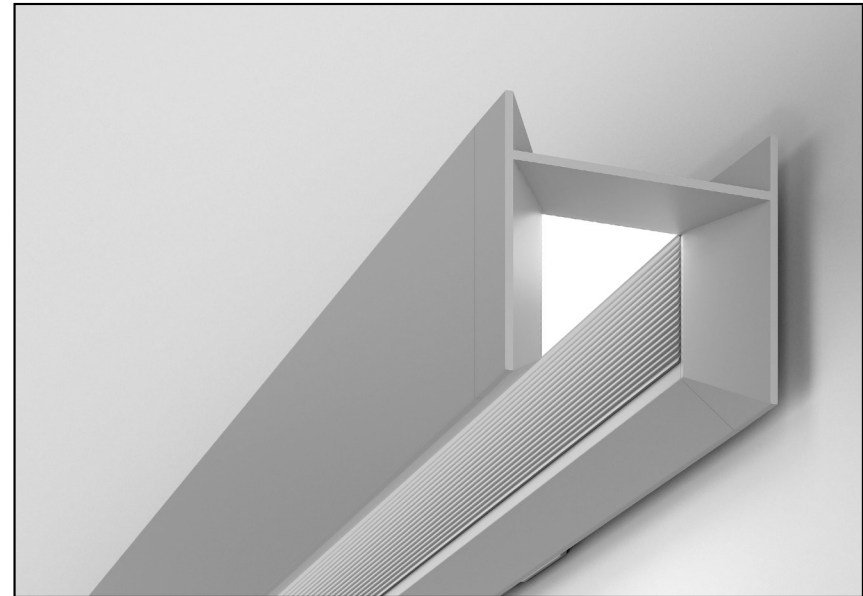

Zen Square is also available in wall mount.



Zen Beam Recessed

About Axis Lighting

Founded in 1991 and still family owned and managed, Axis is an important source for architectural lighting across North America and around the globe.

Over the last decade, the company has exhibited remarkable growth thanks to its commitment to Design Flexibility, Optimal Energy Efficiency and Responsive Customer Care. That leadership effort now extends to developing Innovative Lighting Technologies, such as SurroundLite™, on an ongoing basis.

On the strength of a broad and expanding product line, Axis has successfully completed lighting projects for high-profile clients including Apple, Chrysler, The Empire State Building, Google, Hyundai, Time Warner and McGill University, among many others.

Axis has the drive and the expertise to meet your needs and provide architectural lighting... your way.



We reserve the right to change specifications without notice.
Please consult our website for the most current technical information
and to locate your nearest Axis representative.

1.800.263.AXIS
[T] 514.948.6272
[F] 514.948.6271

axislighting.com

© 2018 Axis Lighting Inc.